

B-B (1:1)

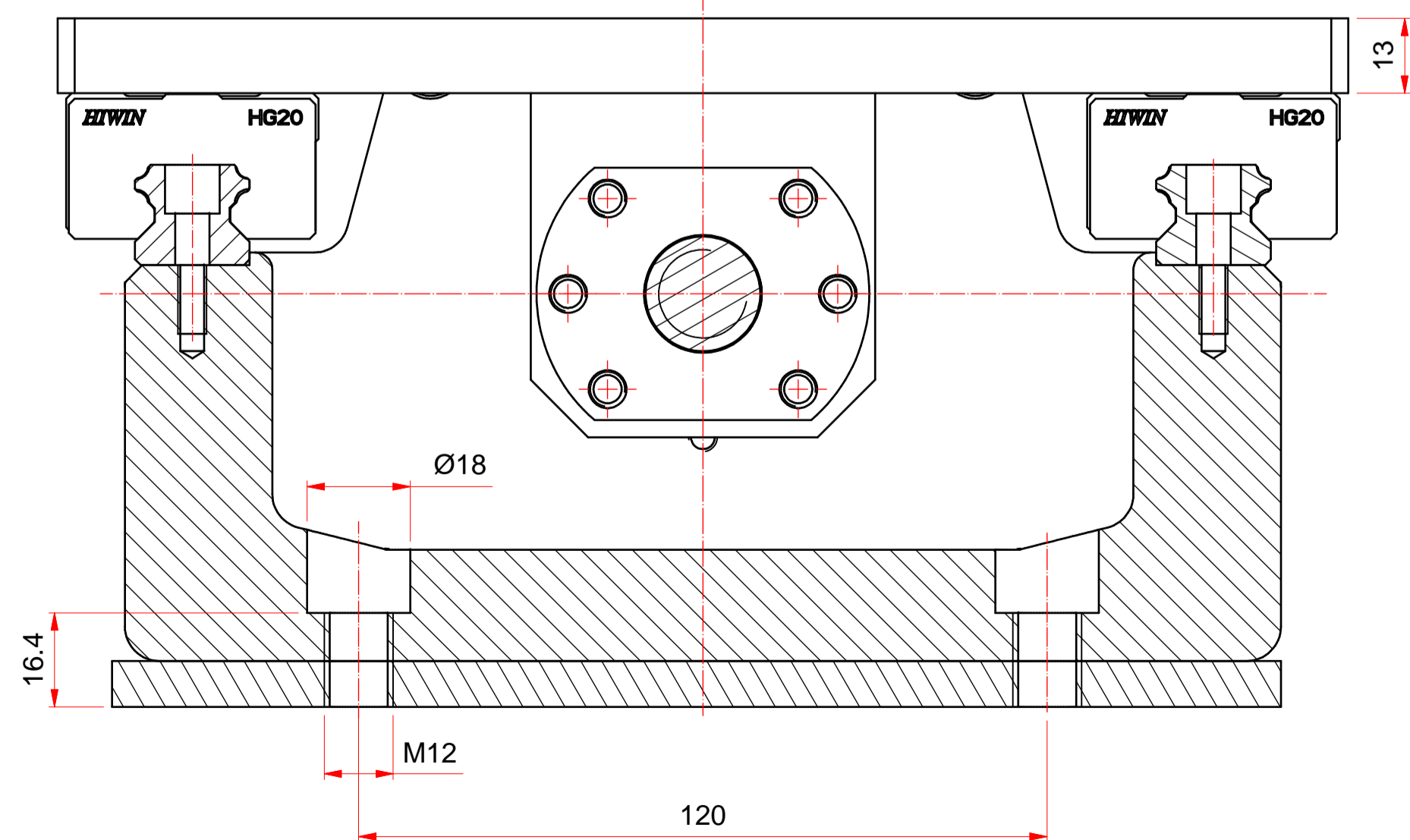

A (2:1)

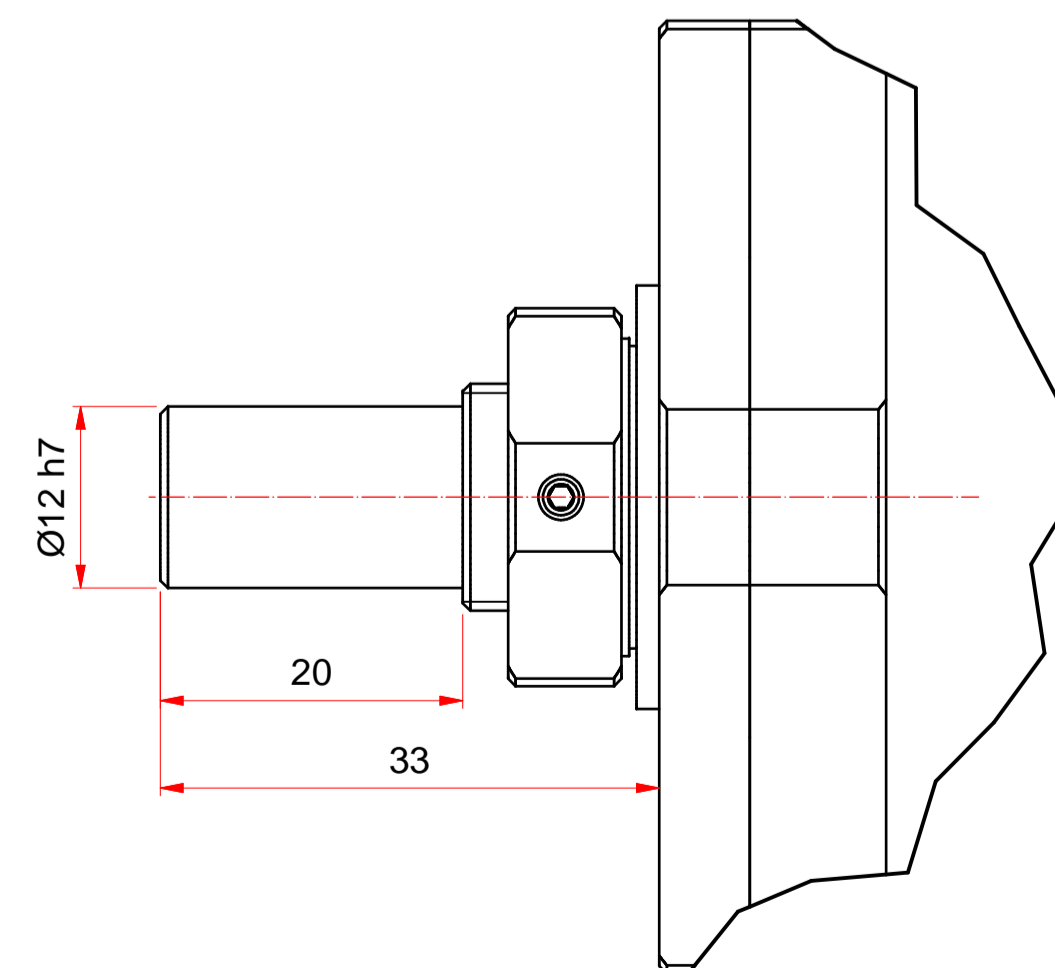

KK-HD-225-20XX-YYYY
XX
05
10
20

OVERALL TREATMENT: BLACK OXIDE COATING  
CHASSIS COLOR: PAINT, RAL 7035

✓	✓	✓	GENERAL TOLERANCES	ISO 2768-mk	ASSEMBLY No.	QUANTITY
Specified roughness Ra	DIMENSION	ANGLE	WELD DIN 8570-BF	TITLE		
Ra	UNIT	MATERIAL :	ASSEMBLY			
mm	FORM	TREATMENT :	DRWG. No.			
SCALE	1:2	PROJ :	CLIENT :	KK-HD-225-20-20XX-0500-A01		
FORM	A1	REV. No. :0	ACE	DAT. : 2/02/2009	PAG. 1 / 2	Vansichen Lineairtechniek