

B-B (1:1)

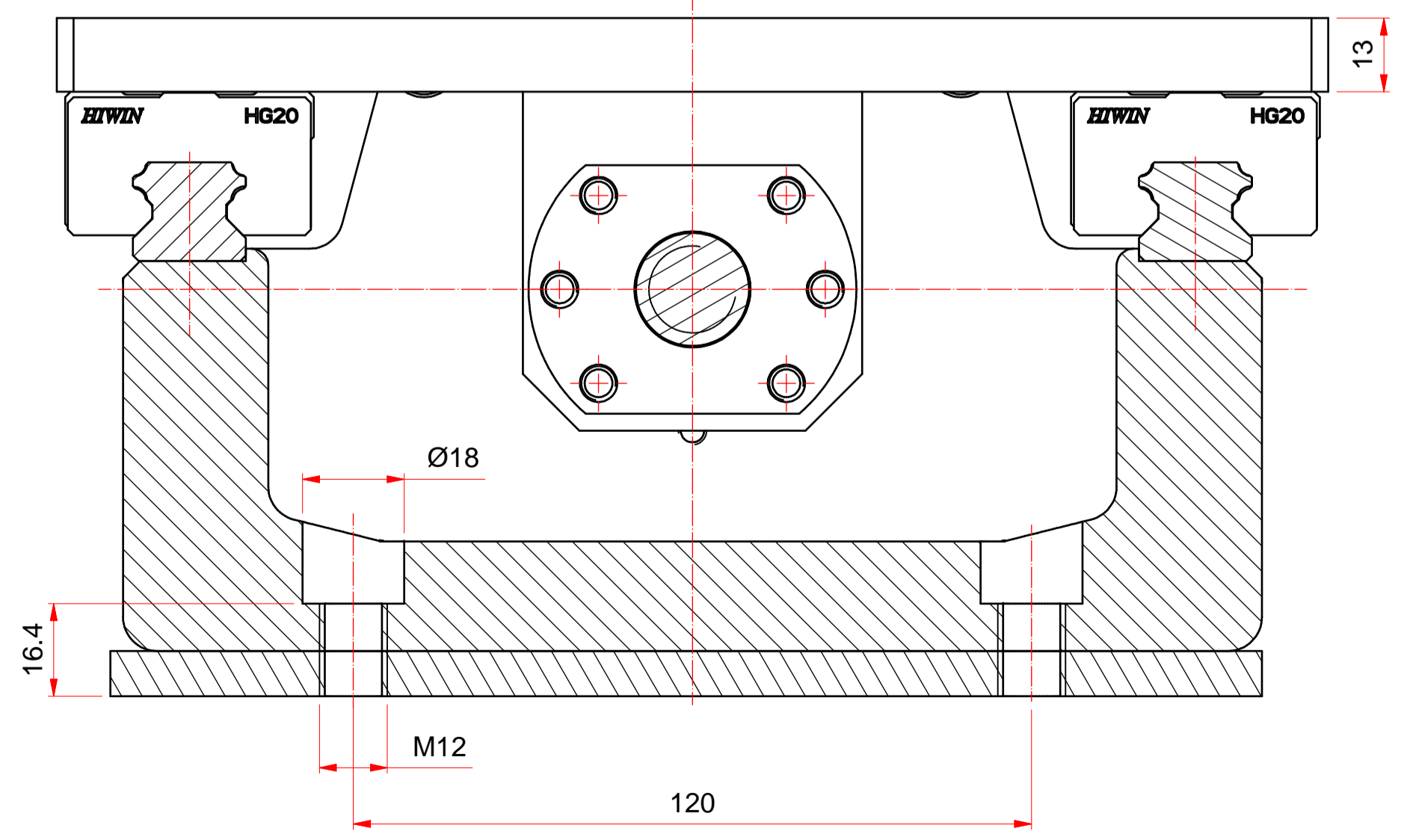

A (2:1)

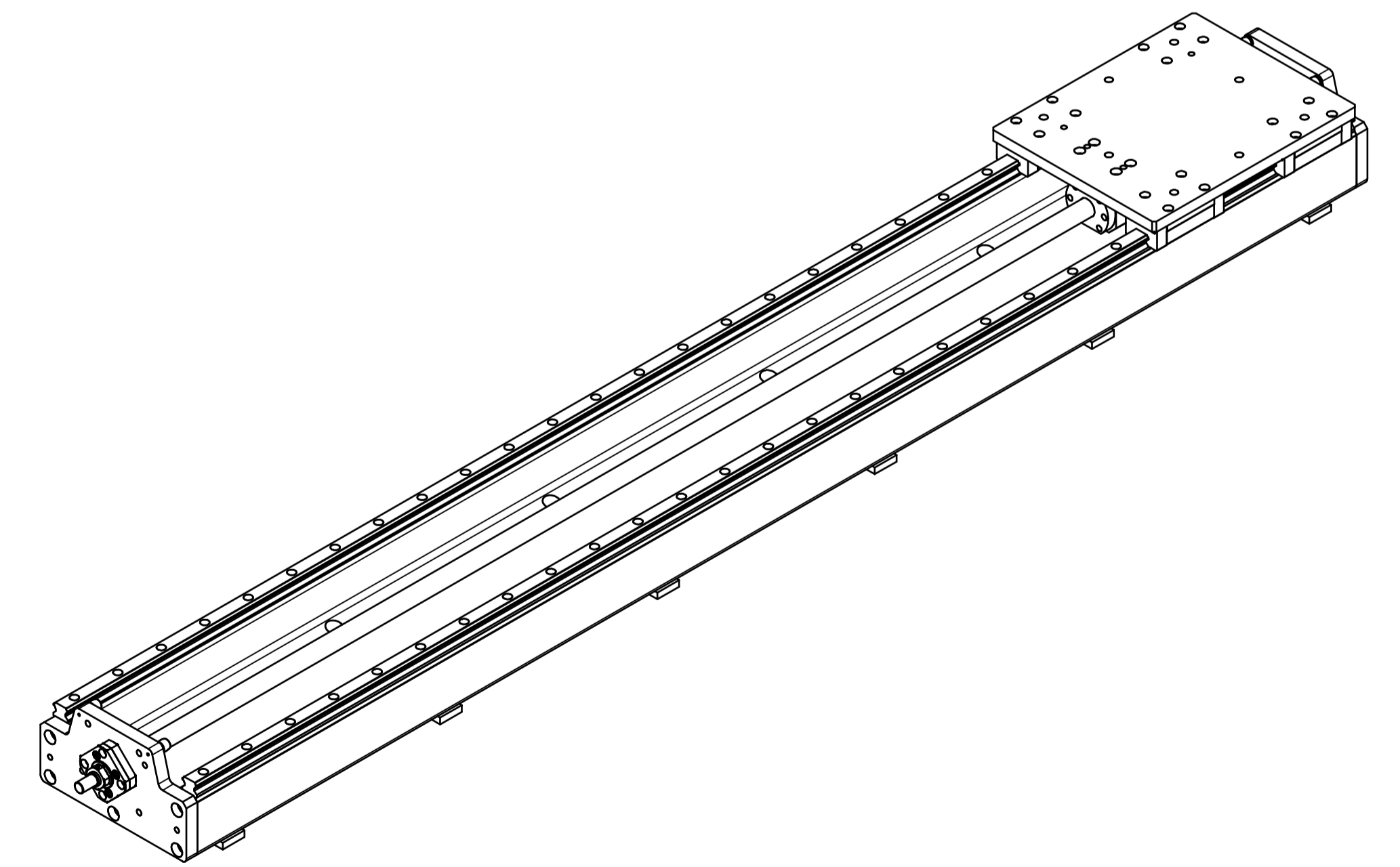
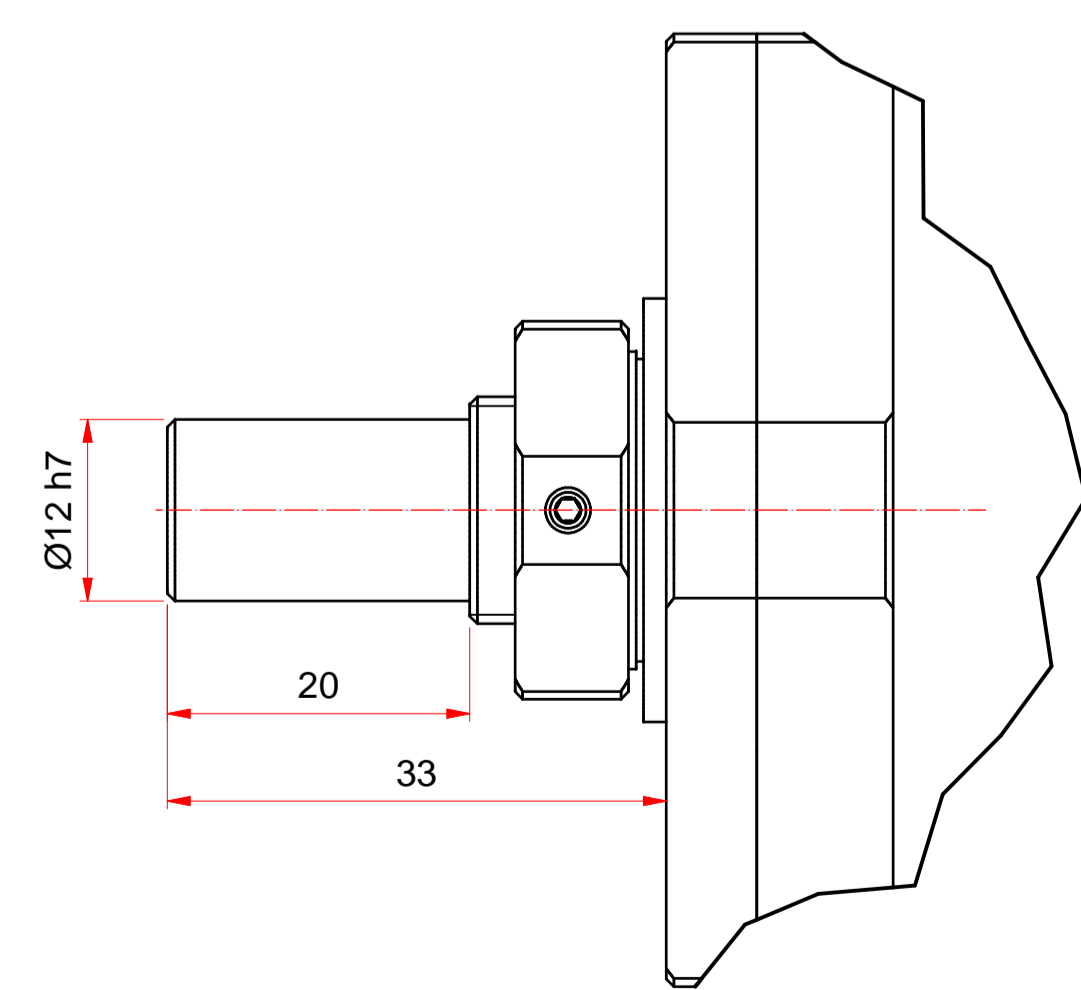

OVERALL TREATMENT: BLACK OXIDE COATING
CHASSIS COLOR: PAINT, RAL 7035

KK-HD-225-20XX-YYYY
XX
05
10
20

✓	✓	✓	GENERAL TOLERANCES	ISO 2768-mk	ASSEMBLY No.	QUANTITY
Specified roughness Ra	DIMENSION	ANGLE	WELD DIN 8570-BF		TITLE	
Ra	UNIT	MATERIAL :			ASSEMBLY	
SCALE	FORM	TREATMENT :			DRWG. No.	
1:2	A1	PROJ :	CLIENT :		KK-HD-225-20-20XX-1600-A01	
REV. No. :0	ACE	DAT. : 2/02/2009	PAG. 1 / 2		Vansichen Lineairtechniek	